

Don't grab the edges  
of the cave when  
picking up or moving

**ATTENTION:** Animal toy - not indestructible! Usage under direct supervision of adults only! Not suitable for children! Danger of swallowing small pieces! Danger of strangulation!

**ACHTUNG:** Tierspielzeug - nicht unzerstörbar! - Benutzung nur unter unmittelbarer Aufsicht von Erwachsenen! Nicht für Kinder geeignet! Gefahr des Verschluckens von Kleinteilen! Gefahr der Strangulation!

**LET OP:** Huisdier Speelgoed- niet onverwoestbaar! Gebruik alléén onder strikt toezicht van een volwassene! - Niet geschikt voor kinderen! - Gevaar voor inslikken van kleine onderdelen! Risico tot wurging!

**ATTENTION:** Jouet pour animal de compagnie - n'est pas indestructible! A utiliser sous la surveillance d'un adulte! - Ne convient pas aux enfants! Risque d'ingestion de petites pièces! Risque de strangulation!

**ATENCIÓN:** Juguete para animales - no es indestructible! Uso bajo supervisión directa de adultos! No es apto para niños! Peligro de ingestión de piezas pequeñas! - Peligro de asfixia!

ebi

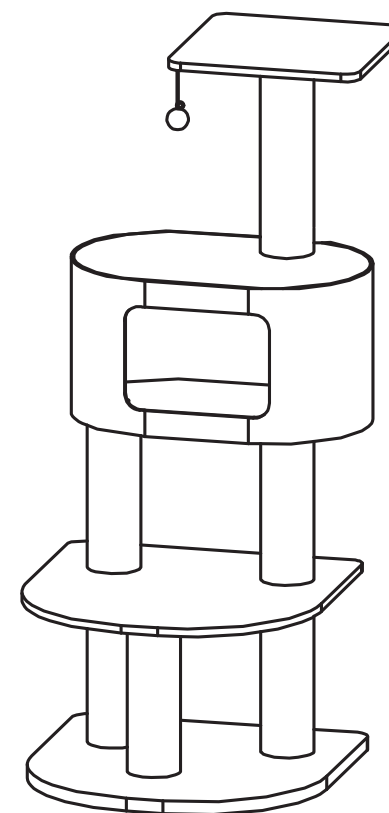

PA07-01-107-06

Ref.No.  
431-470022

ebi

EUROPET BERNINA INTERNATIONAL B.V.  
Energieweg 35, 5422 VM Gemert-Bakel  
The Netherlands  
info@ebi.eu - www.ebi.eu

Part of  
**LAROV**  
GROUP

# Salisbury

Assembly instruction - Bauanleitung - Montage-instructies - Instructions de montage -  
Instrucción de montaje

1

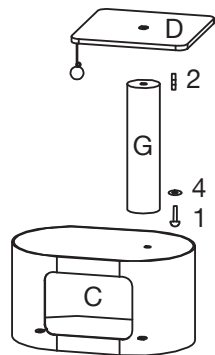

2

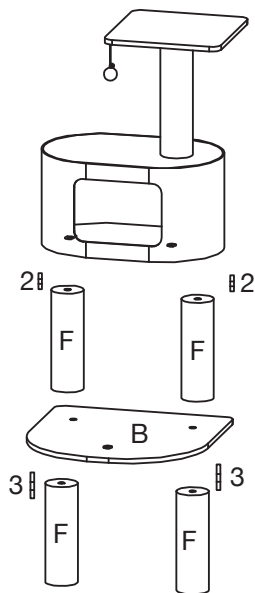

3

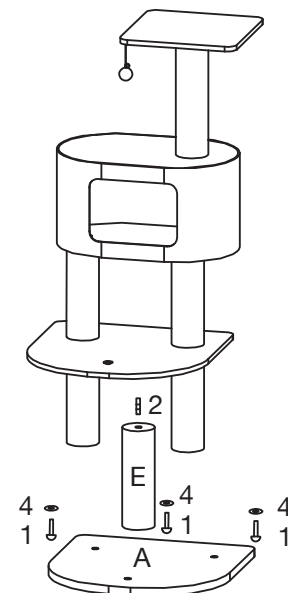

4

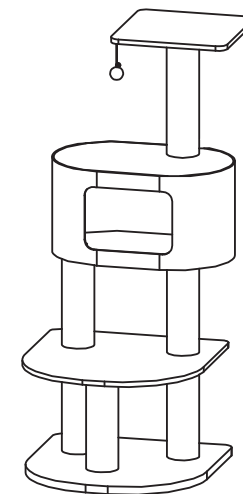

Pièces / Teile / Delen / Parts / Piezas

1X  58 x 58 x 3 cm (A)

1X  58 x 58 x 2 cm (B)

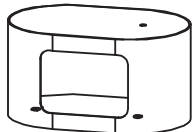
1X  58 x 38 x 30 cm (C)

1X  38 x 38 x 2 cm (D)

1X  plush Ø 10 x 31,5 cm (E)

4X  Ø 10 x 44 mm (2)

1X  Ø 10 x 80 mm (3)

4X  Ø 10 x 50 mm (1)

4X  Ø 10 x 44 mm (2)

2X  Ø 10 x 80 mm (3)

4X  Ø 40 mm (4)

