

ATTENTION: Animal toy - not indestructible! Usage under direct supervision of adults only! Not suitable for children! Danger of swallowing small pieces! Danger of strangulation!

ACHTUNG: Tierspielzeug - nicht unzerstörbar! - Benutzung nur unter unmittelbarer Aufsicht von Erwachsenen! Nicht für Kinder geeignet! Gefahr des Verschluckens von Kleinteilen! Gefahr der Strangulation!

LET OP: Huisdier Speelgoed- niet onverwoestbaar! Gebruik alléén onder strikt toezicht van een volwassene! - Niet geschikt voor kinderen! - Gevaar voor inslikken van kleine onderdelen! Risico tot wurging!

ATTENTION: Jouet pour animal de compagnie - n'est pas indestructible! A utiliser sous la surveillance d'un adulte! - Ne convient pas aux enfants! Risque d'ingestion de petites pièces! Risque de strangulation!

ATENCIÓN: Juguete para animales - no es indestructible! Uso bajo supervisión directa de adultos! No es apto para niños! Peligro de ingestión de piezas pequeñas! - Peligro de asfixia!

PA07-01-116-04

Ref.No.
431-472736



EUROPET BERNINA INTERNATIONAL B.V.
Energieweg 35, 5422 VM Gemert-Bakel
The Netherlands
info@ebi.eu - www.ebi.eu



Orion - 90

Assembly instruction - Bauanleitung - Montage-instructies - Instructions de montage -
Instrucción de montaje

1

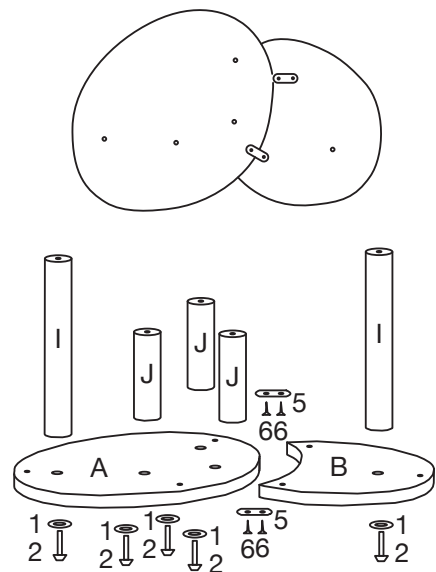

2

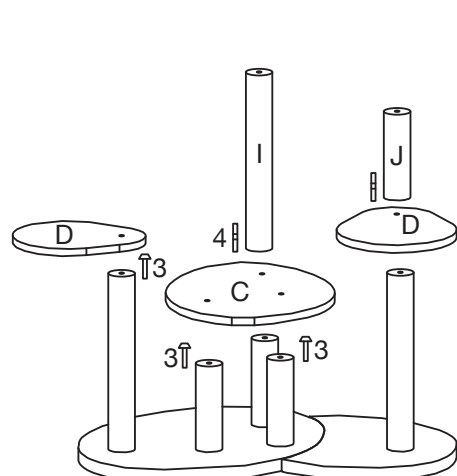



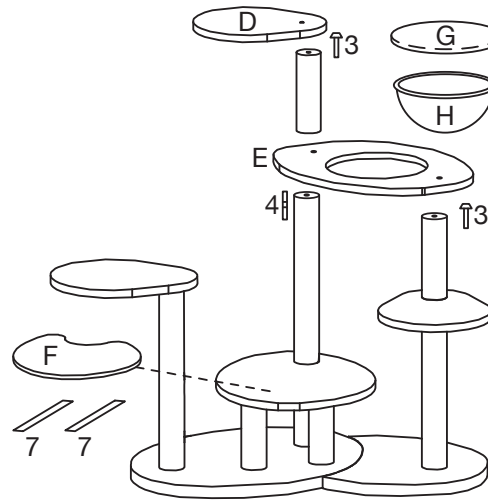

3

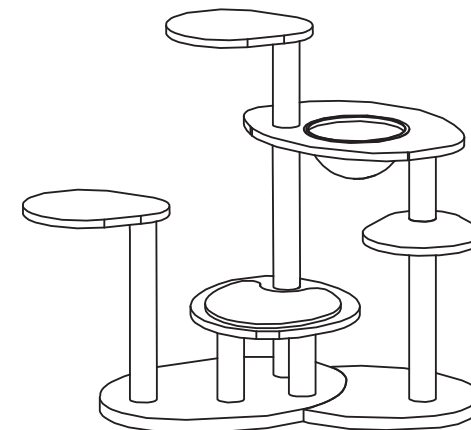





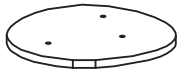



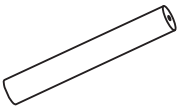

4



Pièces / Teile / Delen / Parts / Piezas

- 1X  65 x 52 x 2,5 cm (A)
- 1X  41,5 x 48 x 2,5 cm (B)
- 1X  38 x 48 x 1,5 cm (C)
- 3X  33 x 27 x 1,5 cm (D)
- 1X  55 x 40,5 x 1,5 cm (E)

- 1X  33 x 40,5 cm (F)
- 1X  Ø 35 cm (G)
- 1X  Ø 30 cm (H)
- 3X  Ø 7,5 x 41 cm (I)
- 5X  Ø 7,5 x 20 cm (J)

- 5X  Ø 30 mm (1)
- 5X  Ø 8 x 60 mm (2)
- 5X  Ø 8 x 50 mm (3)
- 3X  Ø 8 x 70 mm (4)
- 2X  37 x 16 mm (5)
- 4X  Ø 3 x 14 mm (6)
- 2X  30 x 180 mm (7)

