

CHIRPY COURT

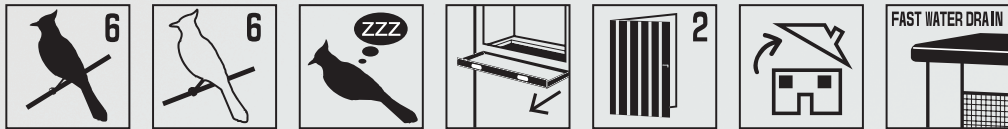

MANUAL

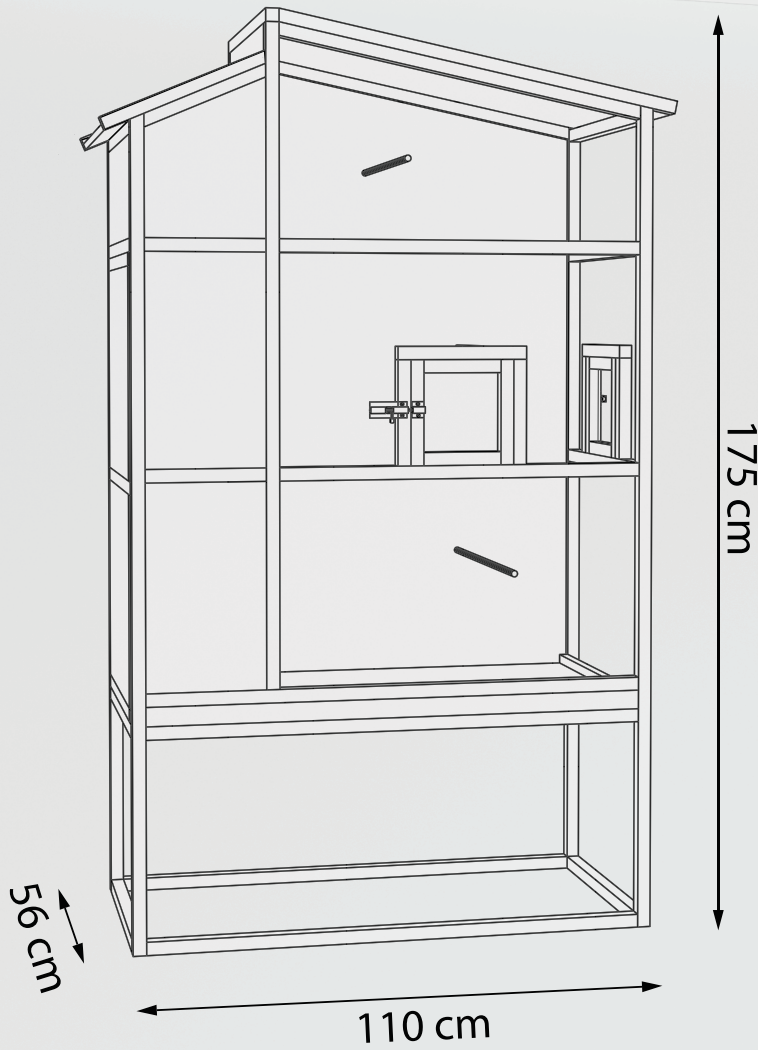

www.duvoplus.com by
Laroy GROUP
 Industrieweg 98-100
 9032 Wondelgem | Belgium
 www.laroygroup.com

f @laroygroup
 Questions? info@laroygroup.com



THESE PARTS:

FASTENERS

(A) 4+1 pcs - $\varnothing 3.5 \times 60$ mm 

(C) 8+1 pcs - $\varnothing 3.5 \times 35$ mm 

(E) 2 pcs - M5 x 40mm 

(B) 20+1 pcs - $\varnothing 3.5 \times 45$ mm 

(D) 4+1 pcs - $\varnothing 3.5 \times 20$ mm 

(F) 1 pcs - 55 x 45 mm 

WOOD PIECES

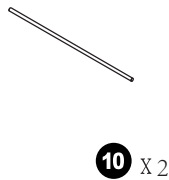
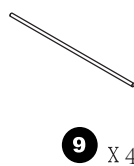
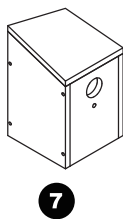
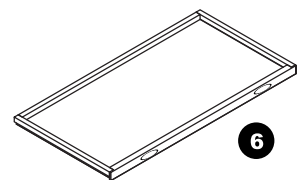
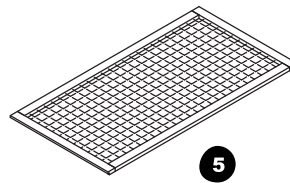
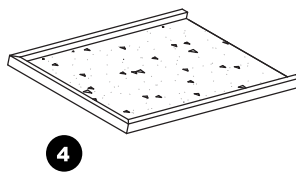
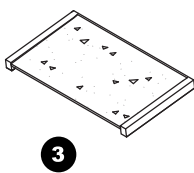
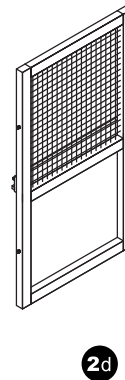
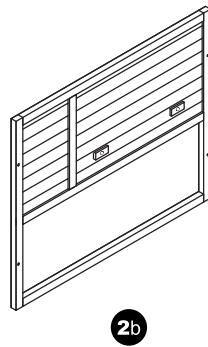
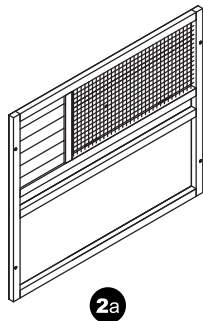
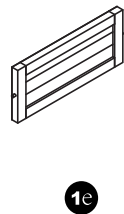
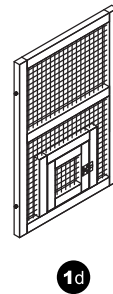
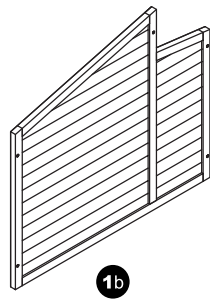
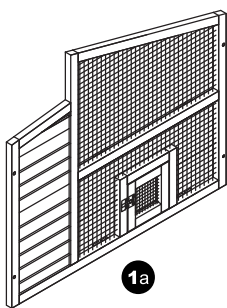

Assembly Instructions

*Use Screwdriver for Assembly

1

1a

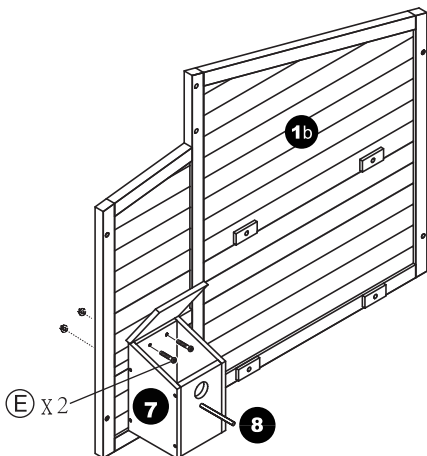

2

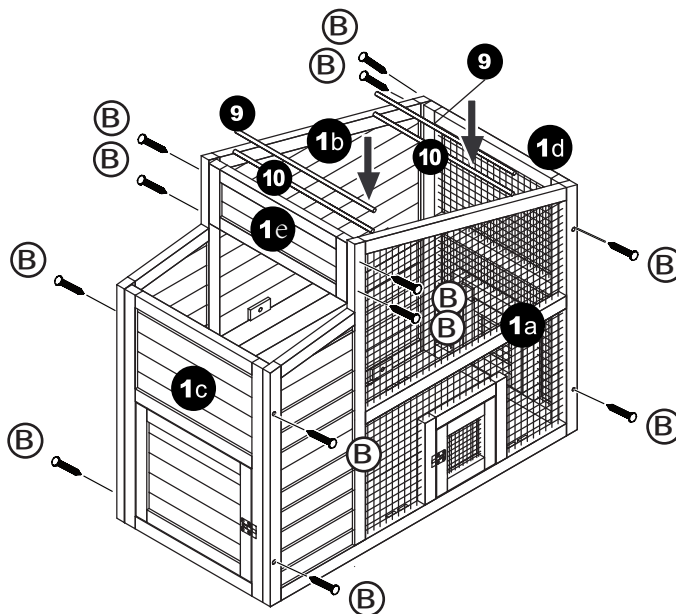

3

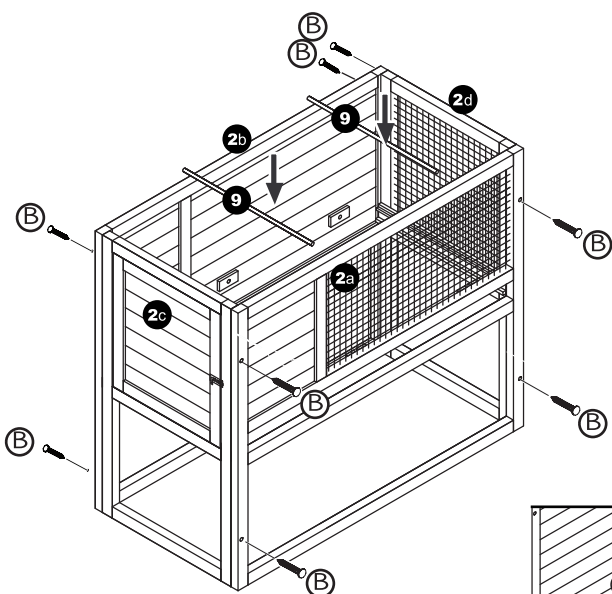

4

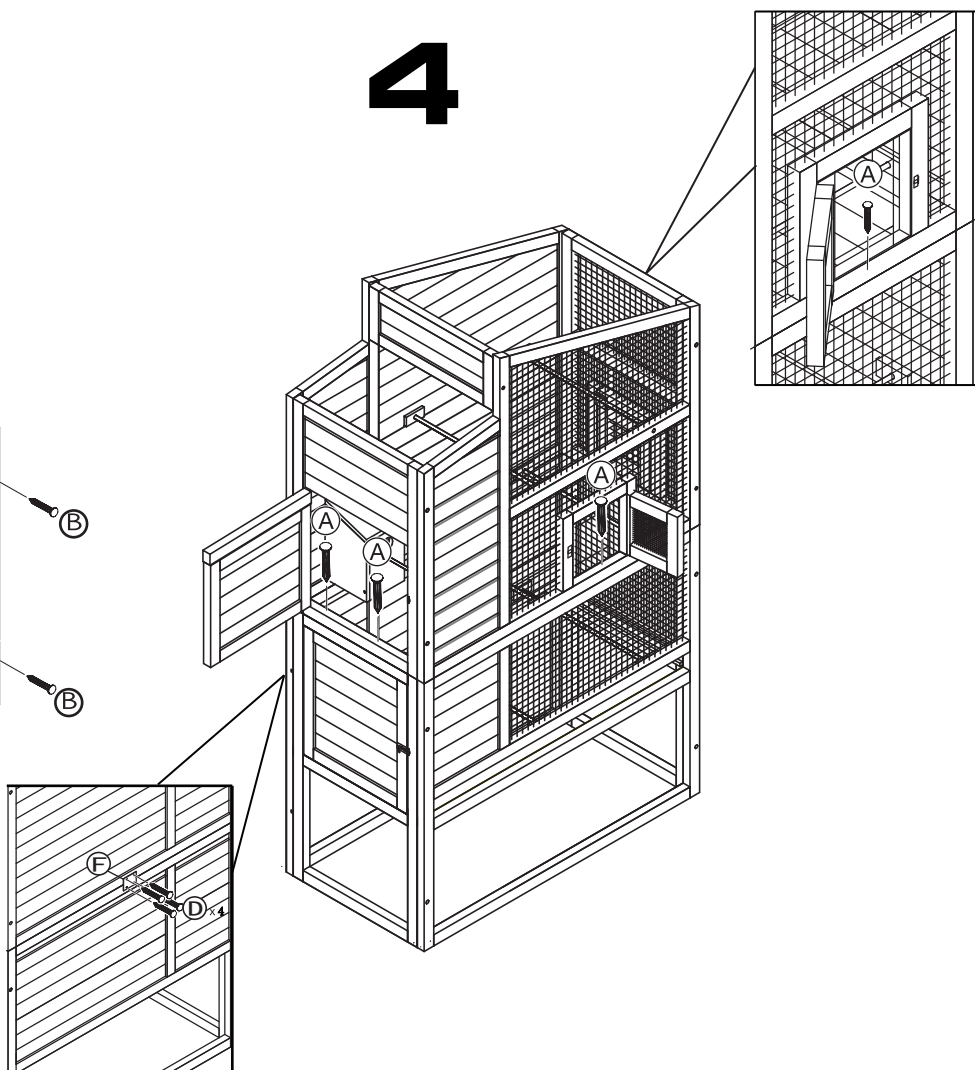

5

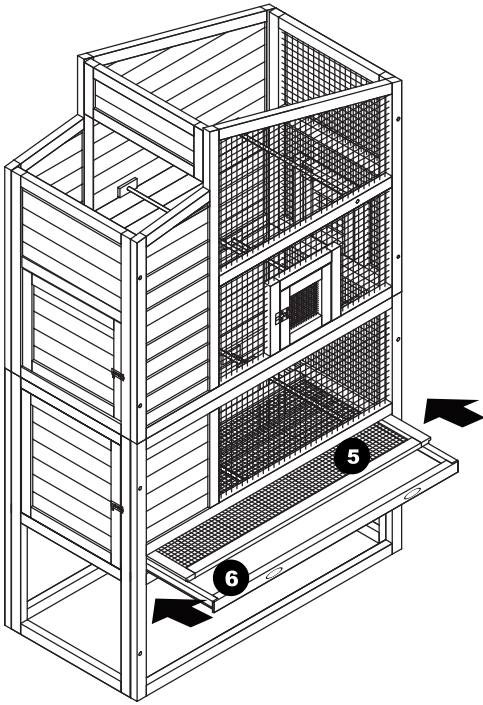

6

